

Operator's Manual

Portable Industrial Endoscope with 3.5" color TFT LCD Monitor

(Suitable for 10.0mm, 8.5mm, 5.5mm,4.5mm,3.9mm camera)



Version: 1.2

GENERAL SAFETY INFORMATION

Thanks for choosing our Portable Industrial Endoscope . It is a worldwide patented product with 3.5" color TFT LCD screen. Please read the operation manual carefully before using this product.

Usage Area Safety

- Keep usage area clean and well lit. (Cluttered or dark areas make accidents easily.)
- Do not operate Portable Industrial Endoscope in explosive atmospheres, such as in the presence of flammable liquids, gases or dust.
- Do not use Portable Industrial Endoscope in an area where it could contact electrical wiring or an electrically charged object. Contact with a "live" wire or object will make exposed metal parts of the tool "live" and can give electrical shock to the operator.
- Do not use Portable Industrial Endoscope near moving machinery.
- Do not use it near any heat sources.
- Keep children and bystanders away while operating a Portable Industrial Endoscope .

Electrical Safety

- Do not expose Portable Industrial Endoscope to rain or wet conditions.

Personal Safety

- Stay alert, watch what you are doing and use common sense when operating a Portable Industrial Endoscope . Do not use a Portable Industrial Endoscope while you are tired or under influence of drugs, alcohol or medication.
- Use personal protective equipment. Always wear eye protection.
- Do not overreach. Keep proper footing and balance at all times.

Portable Industrial Endoscope Use and Care

- This Portable Industrial Endoscope (Visual Inspection Camera Device) is not intended for medical use or personal inspection.
- Store idle Portable Industrial Endoscope out of reach of children and do not allow persons unfamiliar to Portable Industrial Endoscope or these instructions to operate Portable Industrial Endoscope .
- Maintain Portable Industrial Endoscope . Check for misalignment or binding of moving parts, breakage of parts and any other condition that may affect Portable Industrial Endoscope operation. Do not use if Portable Industrial Endoscope smokes or gives off fumes. If damaged, have the Portable Industrial Endoscope repaired before using.
- Use Portable Industrial Endoscope , accessories and tool bits etc., in accordance with these instructions, taking into account the working conditions and the work to be performed.
- Clean only with dry cloth.
- Always remove the battery pack before cleaning.
- Portable Industrial Endoscope is designed to be powered by 4ea Alkaline AA batteries.

Battery Use and Care

- Change the batteries only with Alkaline AA batteries.
- When the battery is not used, keep it away from other metal objects like paper clips, coins, keys, nails, screws, or other small metal objects that can make connection from one terminal to another.
- Under abusive conditions, liquid may be ejected from the battery, avoid contact. If contact accidentally occurs, flush with water. If liquid contacts eyes, additionally seek medical help.

Service

- Contact a distributor or shop for all repairs. Have your Portable Industrial Endoscope serviced by a qualified repair person using only identical replacement parts.
- Never disassemble the Portable Industrial Endoscope or try to do any rewiring on Portable Industrial Endoscope 's electrical system.

Portable Industrial Endoscope Overview - 1

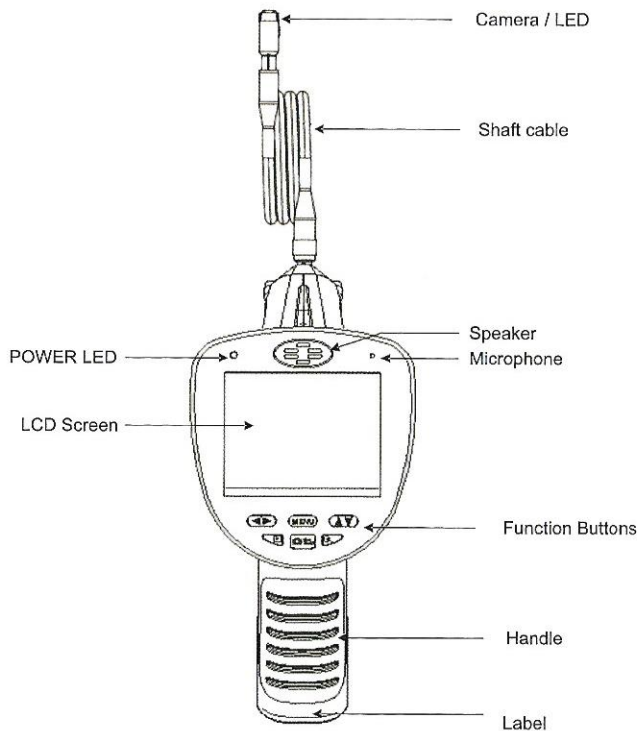

Portable Industrial Endoscope Overview - 2

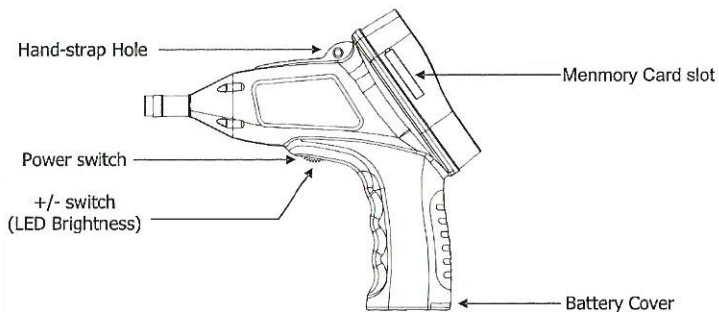
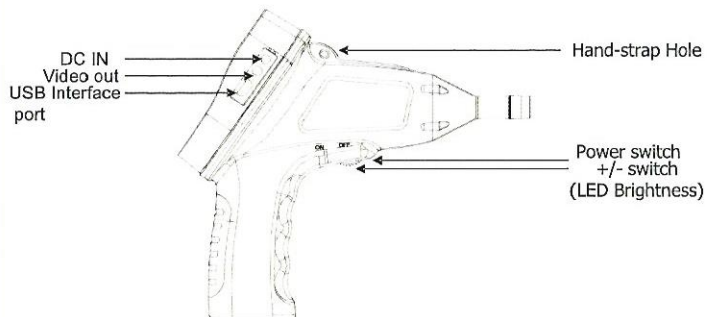

Control LED Brightness

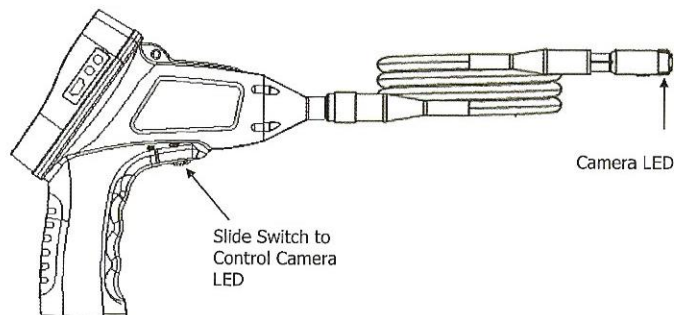

Caution:

Slip to "ON" to brighten the LED Light and

Slip to "OFF" to darken the LED light on the handle.

Be careful not to touch the Lens or LED part in the end of Portable Industrial Endoscope Shaft. If it is touched or is dirty, it will affect the clearance or resolution of displayed image.

If the Lens or LED part is dirty or touched, then the Lens or LED part can be cleaned by a dried and soft cloth.

Inserting/Removing the Battery

Warning:

Use only Alkaline battery. Read following instructions before changing the batteries.

1. To insert or remove the batteries, loosen the screw on the bottom side in the handle part and pull the battery cover down.

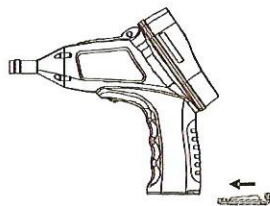

2. Take the Battery cartridge out and insert four (4) AA batteries, as shown.



3. Check the "Arrow" sign on the battery cartridge and put the battery pack inside the Portable Industrial Endoscope body following the direction of "Arrow" sign.

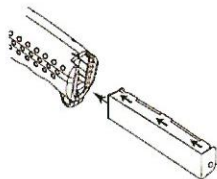

4. Insert battery cartridge into the handle and close the battery cover.

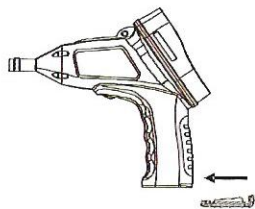

Installing the Flexible Camera Shaft

1. Pull the cover on the back of Portable Industrial Endoscope .
2. Take the Detent to Tab and meet the connector.
3. Pull the cover forward and rotate the cover in the Portable Industrial Endoscope .

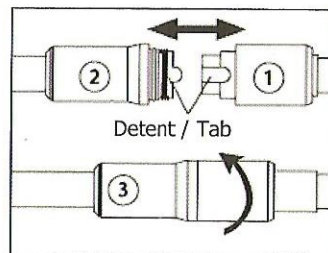

Warning:

- Do not apply strong force while connecting the flexible Camera Shaft to Portable Industrial Endoscope .
- To reduce the risk of injury, wear safety goggles or glasses with side shields. Always remove battery before changing accessories or making adjustments.

Installing the accessories

Four accessories (mirror, hook and magnet) are attached in the same way to the imager head. To connect hold the imager head, slip the end of the accessory over the flats of the imager head.

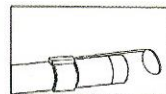
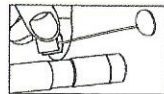

Operation of Portable Industrial Endoscope

✓ Power ON/OFF

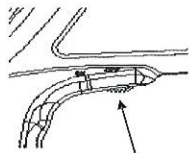

Slide Switch

1. Slide the Switch to turn the Portable Industrial Endoscope on.
2. The moving picture will be shown on the screen and the LED light in the Slide Switch will turn on when the power turns on.
3. Slide the Switch again to turn the Portable Industrial Endoscope off.

✓ LED On/Off

Slide the switch to "ON" to turn LED on and to brighten the LED Light on the handle and Slide the switch to "OFF" to turn LED off and to darken the LED light on the handle.

✓ Battery Life

Change the batteries promptly, when the Portable Industrial Endoscope is turned off or can't power on.

Inserting/Removing SD Card



1. Open the protective rubber cover to access memory card slots
2. Slide the memory card into the slot, the top of the Card should face opposite to the LCD Screen. Press in the card carefully and securely. It should click in place.
3. Close the protective rubber cover.
4. To remove the memory card, press the memory card in and release. It will pop out.

Note:

When the memory card is inserted to Memory Card Slot, then the icon of  will be displayed to the LCD Screen.

When the memory card is write protected, the  icon will be displayed when taking picture or movie. No pictures or movies can be saved to the memory card.

The number of pictures that can be taken or movies recorded is based on the capacity of the memory card. If the memory card is full, the  icon will be displayed when taking a picture or movie. Nothing additional can be saved to the memory card.

Battery Gauge

The Battery Gauge is displayed in the higher right **corner** of the LCD while the Portable Industrial Endoscope is on.



Full Battery Life



2/3 Battery Life



1/3 Battery Life



No Battery Life





Downloading to a computer

Insert the USB cable into the port on the side of the Portable Industrial Endoscope . Connect the USB end into the USB port on your computer.

Note:

- If you are unable to view the videos on your computer it maybe because your computer is missing or does not installed the DIVX or XVID codec. The AVI file is recorded in MPEG4 format and your computer needs a DIVX or XVID codec to decode and play it. For more trouble shouting tips, please ask help from your local distributor and refer to the instructions.

Set up Menu



	Preview image Manual Capture photo or video under preview mode(Photo/Photo3/Movie/Movie clip(1 min) Play/pause under playback mode
	Switch between play & preview mode
	Review next picture or movie under playback mode Select the right or left menu under MENU mode
	Review next Picture or movie under playback mode Select the top or next menu under MENU mode
MENU	Menu for advanced setting
	Zoom In/Out (Max. X5) Thumbnail under playback mode Rotate the LCD Screen at 180° (Long Key 3sec.)

To enter the set-up menu, turn on the machine and press MENU Button. Use<▶▶ ▶▶▶ Buttons to select and confirm the Menu by pressing MENU button.







Monitor with buttons









Preview

On pressing the On/Off button, the booting image of camera displays. On the screen, the  icon shows photo mode and the  icon shows movie mode. There is four preview models: Photo, Photo3, Movie, Movie Clip (limited to 1 minute)

Capture Photo and View

In Preview of photo mode, to take capture of photo and stop it, press the  button. The Capture of Photo performs with showing  icon on the screen and sound. To see the Photo captured, press the  Button. The photo is selected by pressing the  button for the previous or next photo.

Taking Video and Play





To take video with sound and stop it, press the  button in Preview of Video mode. Push  button to stop video taking. On recording the video mode, the  icon blinks. Press the  button to change the Preview mode and Playback mode. The video is selected by pressing the  button for the previous or next video, then push  Button to start play video. On playing back,  icon will display and On stopping,  will display by pushing  button.

ZOOM IN/ZOOM OUT

To operate Zoom In mode, press the  button. The ZOOM IN function can be operated to 1~5times. It will escape ZOOM IN mode after it goes up to 5times ZOOM IN.

MENU (On Preview mode)

There are four main menu that user can set up under preview mode. Push  button to select the MENU which you want to set up.

	Manual Capture
	Advanced Setting
	Language Select
	Time Set up

Manual Capture

Push "Menu" button under preview mode to get the manual capture set up screen. Use button to select the Capture mode from Photo1, Photo3, Movie, Movie Clip and EXIT.

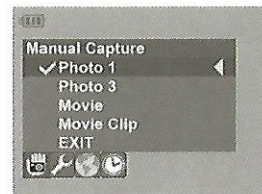

Photo 1







To take only 1 photo by pressing the  button, select Photo 1 by pressing MENU button and exit by the  button.

Photo 3

To take 3ea photos by pressing 1 time the  button, select Photo 3 by pressing MENU button and exit by the  and MENU button. On Preview screen, the  icon will show up.

□ Movie

To record the movie by pressing the  button, select the Movie by pressing MENU button and exit by the ▲▼ and MENU button.

□ Movie Clip

To record only 1 minute movie, select Movie Clip by pressing MENU button and exit by the▲▼ and MENU button.

□ EXIT

Select EXIT bar and push MENU button to exit the set up mode.

Note:

To transfer from Photo mode to Movie mode, press MENU button and select Movie or Movie Clip and press again the MENU button. On completing, press▲▼ and select EXIT and press MENU button again. Press the  button, then the screen is back to the Preview of Movie mode. To transfer from Movie mode to Photo Mode, go to main MENU window.

Advanced Setting





This section is for setting up advanced functions of Portable Industrial Endoscope . Use ◀ ▶ button to enter the Advanced Setting.

□ Photo Quality

To control the Photo Quality, select Advanced Setting => Photo Quality and press MENU Button. Among High Quality, Standard Quality, Low Quality, select 1 item and exit.



-  • High Quality: 720*480 Resolution, Low compressed JPEG file
-  • Standard Quality: 720*480 Resolution, standard compressed JPEG file
-  • Low Quality: 720*480 Resolution, High compressed JPEG file

□ Movie Quality

To change the quality of Movie, select Advanced Setting => Movie Quality and press MENU button. Among QVGA and D1, select 1item and exit.



-  • QVGA: 320*240 30fps AVI file (Video codec: MJPEG)
-  • D1: 720*480 30fps AVI file (Video codec: MJPEG)

□ TV Out Standard

To change the TV Output Standard, select Advanced Setting => TV Output Standard and press MENU button. Between NTSC and PAL, select 1 and exit.

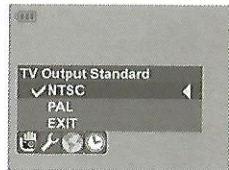

□ Format

To format your SD Card, select Advanced Setting => Format and press MENU button. On screen, the confirmation for format will come out. If you want to format the card, then select YES and press MENU button, if not, select NO and press MENU button.

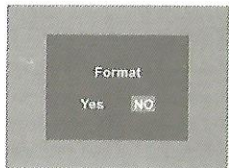

Language Select

On Preview mode, press MENU buttons and move to "Language Select" section by pressing <> buttons and select the language which you want to set up. On completing the selection of language and press MENU buttons. To escape this section, press ▲▼ and select EXIT and press MENU button. There are three languages included: English, German and Chinese.

Time Set up

To set Time and Date, press MENU button and select Set Time/Date section by pressing <> button.



□ Set Time/Date

To enter the Set Time/Date section, the screen displays as below;

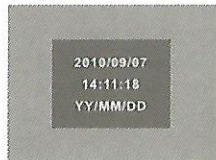

The first line means Year/Month/Day and the second line means Hours / Minutes / Seconds.

To change the value, select the value by pressing <> button and change the time by pressing ▲▼ button.

□ Photo Time Stamp



To display or close the Photo Time Stamp, select Photo Time Stamp by <> pressing button and press MENU Button. To turn on or off the Photo Time Stamp, select ON or OFF by pressing ▲▼ button and press the MENU button.

□ Movie Time Stamp



To display or close the Movie Time Stamp, select Movie Time Stamp by pressing <> and Press MENU button. To turn on or off the Movie Time Stamp, select ON or OFF by pressing the ▲▼ button and press the MENU button.

Playback Mode

When you push MENU button on Playback mode, it goes to the file delete and format menu.

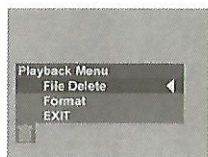

File Delete

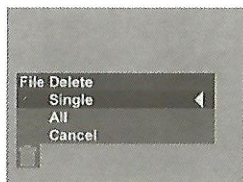

To delete the photo captured or video taken, select "File Delete" and push "MENU" Button to enter in to sub-menu. To delete 1 file only, then select "Single" and press MENU button. To delete all files in SD Card, select "All" and press MENU. To exit file delete menu, select "Cancel" and press MENU button.

Format

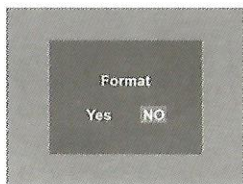

To format SD Card, select Format and press MENU. Select "Yes" and push Menu button to start format. To escape the format, select "No" and press MENU. (Same as above format menu)

EXIT

To escape Playback MENU, select EXIT by pressing the $\blacktriangle\blacktriangledown$ button and press MENU button.

File View by Thumbnail type



To view the files which are taken or recorded, press the \blacktriangleright button to Playback mode and press the magnifying glass button. To Playback movies or pictures in the Thumbnail, select the movie by pressing the \blacktriangleleft or \blacktriangleright button and press MENU button and play button after selecting the file to play. To return the Thumbnail type View, pause or stop the movie by pressing the stop button and press the \blacktriangleleft button and MENU button by step.

TV Out

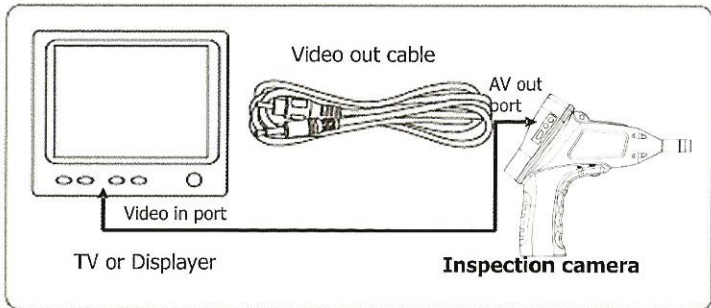
To display **inspection camera** moving picture out to TV or other displayer, connect Video-out cable into **inspection camera's** AV Out port and video in port on the TV or other displayer. On Video-out to TV or other displayer, the sound comes out from inspection camera, not from TV or other displayer.



Accessories

		
AV out cable	USB Cable	

Operation manual including in the package.

Specification (Body part)

- 3.5" TFT LCD Screen (QVGA 320 x 240, 16.7M colors)
- Camera unit: Water Splash Resistance (IPX67)
- Image Capture in JPEG file format
Video Recording in Motion JPEG (AVI file format)
- Resolutions: Image – Standard JPEG,
Video (w/audio) – up to D1 resolution @30fps
- Zoom In/Out (Max.5X)
- Interface: SD Card (up to 32GB SDHC),
USB 2.0 (compatible to USB 1.1),
Composite Video Out
- Changeable and detachable Camera Shaft (10.8/8.5/5.5mm)
- NTSC/PAL Video Out changeable
- OSD Language: English – Default and other languages
- Battery: AA type Alkaline Battery 4ea (Working time: 3~4hours)

Specification (Shaft)

Camera Shaft part

Camera Outer meter	10.0/8.5mm	5.5mm	4.5/3.9mm
Image Sensor	1/9" VGA CMOS Image Sensor	1/12" VGA CMOS Image Sensor	1/18" VGA CMOS Image Sensor
Array Size	640 x 480	640 x 480	320(H)x240(V)
Resolution	0.32M pixels	0.32M pixels	0.1M pixels
Max image Transfer Rate	60fps for VGA 120fps for QVGA	60fps for VGA 120fps for QVGA	60fps for VGA 120fps for QVGA
Sensitivity	1.3V/(Lux.sec)	1.3V/(Lux.sec)	350mW/(Lux.sec)
Focal Range	6CM	6CM	6CM
Optimized Focal Range	2CM ~ 15CM	2CM ~ 15CM	2CM ~ 15CM
Shaft Length	1M	1M	1M
LED Light	4LEDs	4LEDs	2LEDs
Accessories	Hook, Mirror, Magnet (optional)	Hook, Mirror, Magnet (optional)	

Maintenance of inspection camera

Cleaning

- Clean dust and debris from LCD Screen and Battery Pack. Keep **inspection camera** handles clean, dry and free of oil or grease. Use only soap and a damp cloth to clean the **inspection camera**.

Repairs

- For repairs, contact the distributor from which you buy the inspection camera in your territory.

Troubleshooting

- Can't power on: Check your Battery status.
- Can't display the screen to TV: Check the cable is connected right.
- Can't transfer the file to Computer: Check the cable is connected.
- Can't display Preview mode: Check your battery status
- Can't take photos or record video: Check your SD card is inserted and work normally.

Limited Warranty Policy

The inspection camera is warranted to the original purchaser only to be free from defects in material and workmanship.

Subject to certain exceptions, the inspection camera will be repaired or replaced any part on an electric power tool which, after examination, is determined by the manufacturer to be defective in material or workmanship for a period of one (1) year after the date of purchase. Return the inspection camera and copy of proof of purchase to the distributor at your location with freight paid and insured.

This warranty does not apply to damage that the manufacturer determines to be from repairs made or attempted by anyone other than the manufacturer authorized personnel, misuse, alterations, abuse, normal wear and tear, lack of maintenance, or accidents.

Warranty registration is not necessary to obtain the applicable warranty.

The manufacturing date of the product will be used to determine the warranty period if no proof of purchase is provided at the time warranty service is requested.

FCC/CE/RoHS/Recycle